

NEXYS™
FLUX



 **blizzard**

Blizzard Lighting, LLC
<http://www.blizzardpro.com>
Waukesha, WI USA
Copyright (c) 2023

TABLE OF CONTENTS

1. Getting Started	3
What's In The Box?	3
Getting It Out Of The Box	3
Powering Up!	3
Getting A Hold Of Us	3
Safety Instructions	4
2. Meet the Nexys™ Flux	5
Main Features	5
DMX Quick Reference	5
Nexys™ Flux Pin-Up Picture	6
Rear Connections	6
3. Setup	7
Fuse Replacement	7
Connecting A Bunch of Nexys™ Flux Fixtures	7
Data/DMX Cabling	7
Cable Connectors	8
3-Pin??? 5-Pin??? Huh!?!?	8
Take It To The Next Level: Setting Up DMX Control	8
Fixture Linking (M/S Mode)	9
Mounting & Rigging	9
Joining Fixtures	9
4. Operating Adjustments	10
The Control Panel	10
Control Panel Menu Structure	11
DMX Values In-Depth	12
5. Appendix	13
Keeping Your Nexys™ Flux As Good As New	13
Returns (Gasp!)	13
Shipping Issues	13
Dimensional Drawings	15

1. GETTING STARTED

What's In The Box?

- Nexys™ Flux LED Fixture
- Power Cord
- 1x Omega Bracket
- 2x Thumbscrews
- This Lovely User Manual

Getting It Out Of The Box

Congratulations on purchasing the Nexys™ Flux. Now that you've got your fixture, you should carefully unpack the box and check the contents to ensure that all parts are present and in good condition. If anything looks as if it has been damaged in transit, notify the shipper immediately and keep the packing material for inspection. Again, please save the carton and all packing materials. If a fixture must be returned to the factory, it is important that the fixture be returned in the original factory box and packing.

Powering Up!

All fixtures must be powered directly off a switched circuit and **cannot be run off a rheostat (variable resistor) or dimmer circuit, even if the rheostat or dimmer channel is used solely for a 0% to 100% switch.**

AC Voltage Switch - Not all fixtures have a voltage select switch, so please verify that the fixture you receive is suitable for your local power supply. See the label on the fixture or refer to the fixture's specifications chart for more information. A fixture's listed current rating is its average current draw under normal conditions. Check the fixture or device carefully to make sure that if a voltage selection switch exists that it is set to the correct line voltage you will use.

Warning! Verify that the voltage select switch on your unit matches the line voltage applied. Damage to your fixture may result if the line voltage applied does not match the voltage indicated on the voltage selector switch. All fixtures must be connected to circuits with a suitable Ground (Earthing).

Getting A Hold Of Us

If something is wrong, please just visit our website at www.blizzardpro.com/ support and open a support ticket. We'll be happy to help, honest.

Disclaimer: The information contained in this document are subject to change without notice. Blizzard Lighting™ assumes no responsibility or liability for any errors or omissions that may appear in this user manual. We reserve the right to update the existing, or create a new document to correct any errors or omissions. You can download the latest version of this document from www.blizzardpro.com.

Author:	Date:	Last Edited:	Date:
J. Thomas	10/27/2023	J. Thomas	11/7/2023

Safety Instructions



Please read these instructions carefully. They include important information about the installation, usage and maintenance of this product.

- Please keep this User Guide for future use. If you sell the unit to someone else, be sure that they also receive this User Guide.
- ALWAYS make sure that you are connecting to the proper voltage, and that the line voltage you are connecting to is not higher than that stated on the decal or rear panel of the fixture.
- This product is intended for indoor use only.
- To prevent risk of fire or shock, do not expose fixture to rain or moisture.
- Make sure there are no flammable materials close to the unit while operating.
- The unit must be installed in a location with adequate ventilation, at least 20in (50cm) from adjacent surfaces. Be sure that no ventilation slots are blocked.
- ALWAYS disconnect from the power source before servicing or replacing fuse and be sure to replace with same fuse size and type.
- ALWAYS secure fixture using a safety chain. NEVER carry the fixture by its head. Use its carrying handles.
- DO NOT operate at ambient temperatures higher than 104°F (40°C).
- In the event of a serious operating problem, stop using the unit immediately. NEVER try to repair the unit by yourself. Repairs carried out by unskilled people can lead to damage or malfunction. Please contact the nearest authorized technical assistance center. Always use the same type spare parts.
- NEVER connect the device to a dimmer pack.
- Make sure the power cord is never crimped or damaged.
- Never disconnect the power cord by pulling or tugging on the cord.
- Avoid direct eye exposure to the light source while it is on.

Caution! There are no user serviceable parts inside the unit. Do not open the housing or attempt any repairs yourself. In the unlikely event your unit may require service, please open a support ticket at www.blizzardpro.com/support.

2. MEET THE NEXYS™ FLUX

Main Features

- 1x 80W Warm White 2000K LED
- 24x SMD 5050 RGB 0.5W LEDs (6x4 LED sections)
- Smooth dimming (0-100%)
- Warm white strobe + RGB LED background effects
- Built-in programs and manual color mixing
- 5-pin DMX in/out connections
- powerCON™ TRUE1 compatible power in/out
- Dual mounting brackets + omega clamp bracket
- Interlocking housing design for connecting multiple fixtures
- Heavy-duty aluminum enclosure

Control

- Protocol: USITT DMX-512
- DMX Channels: 4/8/20-channels
- Easy-to-use 4-button control menu with LCD display
- Operating modes: DMX512, M/S, auto

DMX Quick Reference (4/8/20-Channel Modes)

4CH	8CH	20CH	What it does
--	1	1	Dimmer (80W LED, 0% --> 100%)
--	2	--	Strobe (80W LED)
1	3	--	Red
2	4	--	Green
3	5	--	Blue
4	6	2	Warm White
--	7	-	Auto Program
--	8	-	Auto Program Speed (0% - 100%)
--	--	3	Red Section 1 (0% - 100%)
--	--	4	Green Section 1 (0% - 100%)
--	--	5	Blue Section 1 (0% - 100%)
--	--	6	Red Section 2 (0% - 100%)
--	--	7	Green Section 2 (0% - 100%)
--	--	8	Blue Section 2 (0% - 100%)
--	--	9	Red Section 3 (0% - 100%)
--	--	10	Green Section 3 (0% - 100%)
--	--	11	Blue Section 3 (0% - 100%)
--	--	12	Red Section 4 (0% - 100%)
--	--	13	Green Section 4 (0% - 100%)
--	--	14	Blue Section 4 (0% - 100%)
--	--	15	Red Section 5 (0% - 100%)
--	--	16	Green Section 5 (0% - 100%)
--	--	17	Blue Section 5 (0% - 100%)
--	--	18	Red Section 6 (0% - 100%)
--	--	19	Green Section 6 (0% - 100%)
--	--	20	Blue Section 6 (0% - 100%)

Figure 1: Nexys™ Flux Pin-Up Picture

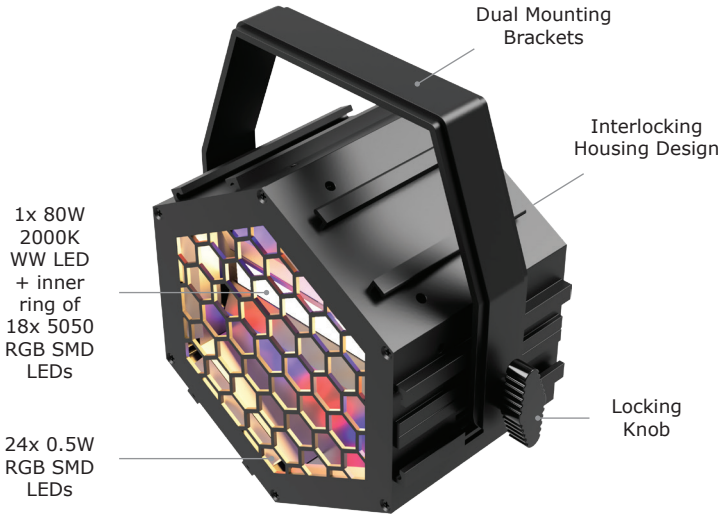
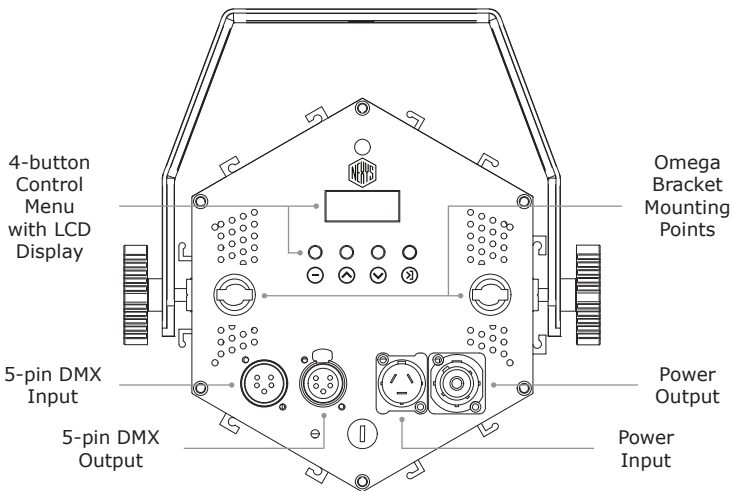

Figure 2: Rear Connections



3. SETUP



Before replacing a fuse, disconnect the power cord.
ALWAYS replace with the same type and rating of fuse.

Fuse Replacement

Remove the fuse holder from of its housing. Then take out the damaged fuse from its holder and replace with exact same type of fuse. Reattach the fuse holder, and then reconnect power.

Connecting A Bunch of Nexys™ Flux Fixtures

You will need a serial data link to run light shows using a DMX-512 controller or to run shows on two or more fixtures set to sync in master/slave operating mode. The combined number of channels required by all the fixtures on a serial data link determines the number of fixtures the data link can support.

Fixtures on a serial data link must be daisy chained in a single line. Also, connecting more than 32 fixtures on one serial data link without the use of an optically-isolated DMX splitter may result in deterioration of DMX signal. The maximum recommended cable-run distance is 500 meters (1640 ft).

Data/DMX Cabling

To link fixtures together you'll need data cables. You should use data-grade cables that can carry a high quality signal and are less prone to electromagnetic interference.

For instance, Belden© 9841 meets the specifications for EIA RS-485 applications. Standard microphone cables will "probably" be OK, but note that they cannot transmit DMX data as reliably over long distances. In any event, the cable should have the following characteristics:

- *2-conductor twisted pair plus a shield*
- *Maximum capacitance between conductors – 30 pF/ft.*
- *Maximum capacitance between conductor & shield – 55 pF/ft.*
- *Maximum resistance of 20 ohms / 1000 ft.*
- *Nominal impedance 100 – 140 ohms*

Disclaimer: The power connectors fitted to the fixture and fixture cord are designed for compatibility with products manufactured by Neutrik AG, Neutrik USA and their related entities, however they are not manufactured by, affiliated with or endorsed by Neutrik AG, Neutrik USA, or any related entity. Neutrik® and powerCON® are registered trademarks of Neutrik AG.

Cable Connectors

Cables must have a male XLR connector on one end and a female XLR connector on the other end. (Duh!)

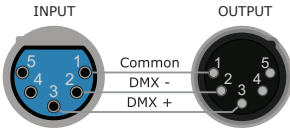

A Word on Termination:

DMX is a resilient communication protocol, but however errors still occasionally occur. Termination reduces signal errors, and therefore best practices include use of a terminator in all circumstances. If you are experiencing problems with erratic fixture behavior, especially over long signal cable runs, a terminator may help improve performance.

To build your own DMX Terminator:

Obtain a 120-ohm, 1/4-watt resistor, and wire it between pins 2 & 3 of the last fixture. They are also readily available from specialty retailers.

CAUTION: Do not allow contact between the common and the fixture's chassis ground. Grounding the common can cause a ground loop, and your fixture may perform erratically. Test cables with an ohm meter to verify correct polarity and to make sure the pins are not grounded or shorted to the shield or each other.

3-Pin??? 5-Pin??? Huh?!?

If you use a controller with a 3-pin DMX output connector, you will need to use a 3-pin to 5-pin adapter. If you'd like to build your own, the chart below details a proper cable conversion:

Conductor	3-Pin Female (Output)	5-Pin Male (Input)
Ground/Shield	Pin 1	Pin 1
Data 1- (Primary Data)	Pin 2	Pin 2
Data 1+ (Primary Data)	Pin 3	Pin 3
Data 2- (Optional)	--	Pin 4 - Do Not Use
Data 2+ (Optional)	--	Pin 5 - Do Not Use

Take It To The Next Level: Setting Up DMX Control

Step 1: Connect the male connector of the DMX cable to the female connector (output) on the controller.

Step 2: Connect the female connector of the DMX cable to the first fixture's male connector (input).

Note: It doesn't matter which fixture address is the first one connected. We recommend connecting the fixtures in terms of their proximity to the controller, rather than connecting the lowest fixture number first, and so on.

Step 3: Connect other fixtures in the chain from output to input as above. Place a DMX terminator on the output of the final fixture to ensure best communication.

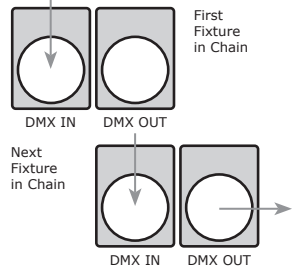

Fixture Linking (M/S Mode)

1. Connect the male connector side of the DMX cable to the output female connector of the first fixture.

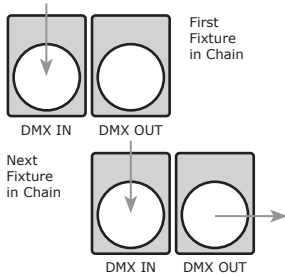

2. Connect the end of the cable coming from the first fixture which will have a female connector to the input connector of the next fixture consisting of a male connector. Then, proceed to connect from the output as stated above to the input of the following fixture and so on.

A quick note: Often, the setup for Master-Slave and Standalone operation requires that the first fixture in the chain be initialized for this purpose via either settings in the control panel or DIP-switches. Secondly, the fixtures that follow may also require a slave setting.

Check the **"Operating Adjustments"** section in this manual for complete instructions for this type of setup and configuration.

Mounting & Rigging

Ensure fixtures have ample ventilation and no obstructions. Regardless of the rigging option, always use a safety cable.

Use "C" or "O" clamps rated 10x the fixture's weight. Only mount on known, strong surfaces and use proper overhead rigging.

Joining Fixtures

Two Fixture Example

2x thumbscrews (front & back)

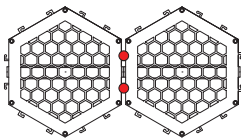

Three Fixture Example

3x thumbscrews (front & back)

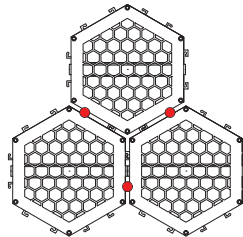

- 1.) If applicable, remove the dual hanging brackets and locking knobs.
- 2.) Align the locking channels of the fixtures and slide them together.
- 3.) On the front and back sides of the adjoined fixtures, use the included thumbscrews to secure them together firmly.





Note: The thumbscrews for any number of joined fixtures should be used on the perimeter of the joined fixture edges on the front and back sides. See illustrations above.

- 4.) Repeat steps 1-3 as needed to add more fixtures.
- 5.) For rigging, you can use the Omega bracket mounting points on the rear side to attach Omega brackets and clamps as needed.

4. OPERATING ADJUSTMENTS

The Control Panel

All the features and different modes possible in this fixture are accessed by using the control panel on the rear of the fixture. There are 4 control buttons which allow you to navigate through the various control panel menus.

-  **<MENU>**
Is used to navigate to the previous higher-level menu item.
-  **<UP>**
Scrolls through menu items and numbers in ascending order.
-  **<DOWN>**
Scrolls through menu items and numbers in descending order.
-  **<ENTER>**
Is used to select and confirm/store the current selection.

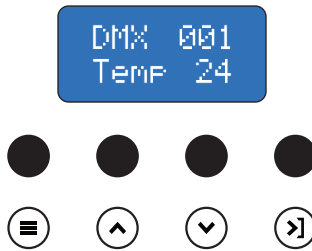

The control panel display shows the menu items you select from the menu map on page #11. When a menu function is selected, the display will show immediately the first available option for the selected menu function. To select a menu item, press **<ENTER>**.

Use the **<UP>** and **<DOWN>** buttons to navigate the menu options. Press the **<ENTER>** button to select the menu function currently displayed, or to enable a menu option. To return to the previous option or menu without changing the value, press the **<MENU>** button.

Control Panel Menu Structure

Address	001-512	Set the starting address from 001-512
CH Mode	4CH	4-channel DMX mode
	8CH	8-channel DMX mode
	20CH	20-channel DMX mode
B Light	Auto	Menu display shuts off after 30s
	Keep	Menu display is always ON
Macro	Auto	Auto Mode
	Manual	Manual Mode
Manual	Red	Red (0-100%)
	Green	Green (0-100%)
	Blue	Blue (0-100%)
	Red	Red (0-100%)
	White	White (0-100%)
	Strobe	Strobe (see DMX values on p.12)
Speed	Slow	Set auto running speed to slow
	Fast	Set auto running speed to fast
Runtime	x.x	Display the fixture total runtime

DMX Values In-Depth (4/8/20-Channel Modes)

4CH	8CH	20CH	Value	What it does
--	1	1	000 <-> 255	Dimmer (0% - 100%)
--	2	--	000 <-> 003 004 <-> 103 104 <-> 107 108 <-> 207 208 <-> 251 252 <-> 255	Strobe Open Strobe (slow <-> fast) Open Pulse (slow <-> fast) Random (slow <-> fast) Open
1	3	--	000 <-> 255	Red
2	4	--	000 <-> 255	Green
3	5	--	000 <-> 255	Blue
4	6	2	000 <-> 255	Warm White
--	7	-	000 <-> 255	Auto Program
--	8	-	000 <-> 255	Auto Program Speed (0% - 100%)
--	--	3	000 <-> 255	Red Section 1 (0% - 100%)
--	--	4	000 <-> 255	Green Section 1 (0% - 100%)
--	--	5	000 <-> 255	Blue Section 1 (0% - 100%)
--	--	6	000 <-> 255	Red Section 2 (0% - 100%)
--	--	7	000 <-> 255	Green Section 2 (0% - 100%)
--	--	8	000 <-> 255	Blue Section 2 (0% - 100%)
--	--	9	000 <-> 255	Red Section 3 (0% - 100%)
--	--	10	000 <-> 255	Green Section 3 (0% - 100%)
--	--	11	000 <-> 255	Blue Section 3 (0% - 100%)
--	--	12	000 <-> 255	Red Section 4 (0% - 100%)
--	--	13	000 <-> 255	Green Section 4 (0% - 100%)
--	--	14	000 <-> 255	Blue Section 4 (0% - 100%)
--	--	15	000 <-> 255	Red Section 5 (0% - 100%)
--	--	16	000 <-> 255	Green Section 5 (0% - 100%)
--	--	17	000 <-> 255	Blue Section 5 (0% - 100%)
--	--	18	000 <-> 255	Red Section 6 (0% - 100%)
--	--	19	000 <-> 255	Green Section 6 (0% - 100%)
--	--	20	000 <-> 255	Blue Section 6 (0% - 100%)

5. APPENDIX

Keeping Your Nexys™ Flux As Good As New

The fixture you've received is a rugged, tough piece of pro lighting equipment, and as long as you take care of it, it will take care of you. That said, you'll need to take care of it if you want it to operate as designed. You should keep the fixture clean, especially if you are using it in an environment with a lot of dust, fog, haze, wild animals, wild teenagers or spilled drinks.

Cleaning the optics routinely with a suitable glass cleaner will greatly improve the quality of light output. Keeping the fans free of dust and debris will keep the fixture running cool and prevent damage from overheating.

In transit, keep the fixtures in cases. You wouldn't throw a prized guitar, drumset, or other piece of expensive gear into a gear trailer without a case, and similarly, you shouldn't even think about doing it with your shiny new light fixtures.

Common sense and taking care of your fixtures will be the single biggest thing you can do to keep them running at peak performance and let you worry about designing a great light show, putting on a great concert, or maximizing your client's satisfaction and "wow factor." That's what it's all about, after all!

Returns (Gasp!)

We've taken a lot of precautions to make sure you never even have to worry about sending a defective unit back, or sending a unit in for service. But, like any complex piece of equipment designed and built by humans, once in a while, something doesn't go as planned. If you find yourself with a fixture that isn't behaving like a good little fixture should, you'll need to obtain a Return Authorization (RA).

Don't worry, this is easy. Just visit www.blizzardpro.com/support and open a support ticket, and we'll issue you an RA. Then, you'll need to send the unit to us using a trackable, pre-paid freight method. We suggest using USPS Priority or UPS. Make sure you carefully pack the fixture for transit, and whenever possible, use the original box & packing for shipping.

When returning your fixture for service, be sure to include the following:

- 1.) Your contact information (Name, Address, Phone Number, Email address).
- 2.) The RA# issued to you
- 3.) A brief description of the problem/symptoms.

We will, at our discretion, repair or replace the fixture. Please remember that any shipping damage which occurs in transit to us is the customer's responsibility, so pack it well!

Shipping Issues

Damage incurred in shipping is the responsibility of the shipper, and must be reported to the carrier immediately upon receipt of the items. Claims must be made within seven (7) days of receipt.

Tech Specs!

Weight & Dimensions	
Width	6.8 in. (173.5 mm)
Depth	4.9 in. (124 mm)
Height	7.9 in. (200.1 mm)
Weight	5.6 lbs. (2.6 kg)
Power	
Operating Voltage	AC 100V-250V/50-60Hz
Power Consumption	83W, 1.1A, PF: .63
Fuse	2A, 250V
Light Source	
LED	1x 80W Warm White 2000K LED 24x SMD 5050 RGB 0.5W LEDs (6x4 LED sections)
Luminous Intensity	213 Lux @ 2.5M 56 Lux @ 5M
Optical	
Beam Angle	120° beam angle
Thermal	
Max. Operating Temp.	104 degrees F (40 degrees C) ambient
Control	
Protocol	USITT DMX-512
DMX Channels	4/8/20-channel DMX modes
Input/Output	5-pin XLR Male/Female
Other Operating Modes	DMX512, M/S, Auto Mode
Warranty	2-year limited warranty, does not cover malfunction caused by damage to LEDs.

Dimensional Drawings

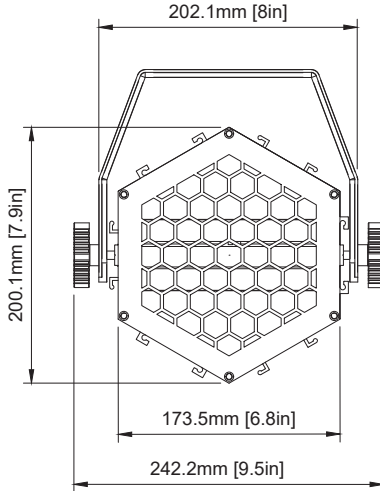
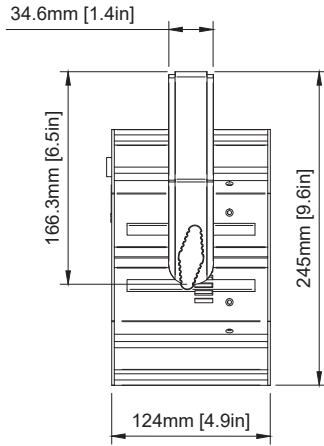



**Enjoy your product!
Our sincerest thanks for your purchase!
--The team @ Blizzard Lighting**